



*Your Vital Air Source*

## ULTRA-LIGHT DUTY ONBOARD AIR SYSTEM

PART NO. 10000

### USER MANUAL



#### IMPORTANT:

It is essential that you and any other operator of this product read and understand the contents of this manual before installing and using this product.

**SAVE THIS MANUAL FOR FUTURE REFERENCE**



# ULTRA-LIGHT DUTY ONBOARD AIR SYSTEM

Thank you for purchasing this complete, self-contained onboard air system. Contained in one package, you'll find everything you'll need to install a high performance, onboard air source for your vehicle. Please follow these instructions to install your new system.

## OBA Components:

- 1 - 1.0 Gallon, 4 port VIAIR Air Tank
- 1 - 98C model VIAIR compressor with leader hose and check valve

(Check to make sure that you have **eight** labeled packages in your kit. Each package contains the parts needed for specific areas of installation, and may contain smaller bags within each package for specific uses.)

## PARTS PACKAGES

### Package #1 – Pressure Switch & Relay:

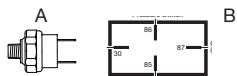

- A. Pressure Switch - (85 PSI on, 105 PSI off) (1pc)
- B. 40-amp relay (1pc)

### Package #2 – Fittings:

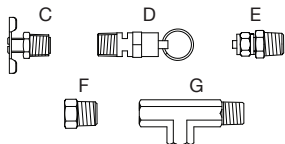

- C. 1/4" NPT Drain Cock (1pc)
- D. 1/4" NPT 145 PSI Safety Valve (1pc)
- E. 1/4" NPT Compression Fitting (1pc)
- F. 1/4" NPT Male Plug (1pc)
- G. T-Fitting – (1/4" M x 1/4" F x 1/8" F NPT) (1pc)

### Package #3 – "Air Out" Air Line (1/4" Air Line):



- H. Air Line for Air Out (25ft)

### Package #4 – Electrical:

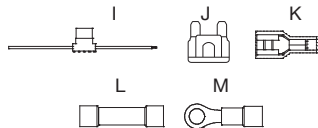

- I. Fuse Holder & 20 ft. 16 Gauge Wire (1pc)
- J. 20-amp Fuse (1pc)
- K. Push-on Female Terminals (4pcs)
- L. 16-gauge Butt Connectors (2pcs)
- M. 16-gauge Ring Terminal (1pc)

### Package #5:

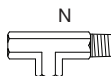

- N. T-Fitting – (1/4" M x 1/4" F x 1/4" F NPT) (1pc)

### Package #6 – BSP Adapters for Air Lockers: (for use with Package #5)



- O. BSP Adapters (1/4" M to 1/8" F BSP) (2pcs)

### Package #7 – Compressor Installation:

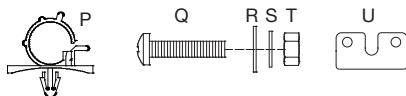

- P. Leader Hose Bracket Clip (1pc)
- Q. Mounting Bolts (4pcs)
- R. Flat Washers (8pcs)
- S. Locking Washers (4pcs)
- T. Nuts (4pcs)
- U. Vibration Isolators (4pcs)

### Package #8 – Air Tank Installation:



- V. Mounting Bolts (2pcs)
- W. Flat Washers (4pcs)
- X. Locking Washers (2pcs)
- Y. Nuts (2pcs)
- Z. Rubber Tank Mount Bushings (2pcs)

# ULTRA-LIGHT DUTY ONBOARD AIR SYSTEM

## 1.0 GALLON AIR TANK & PLUMBING

Your 1.0 gallon air tank comes with four 1/4" NPT port openings. To ensure safe & trouble-free use of your air tank, install the drain cock and a safety pressure relief valve. (See *Figure 1*)

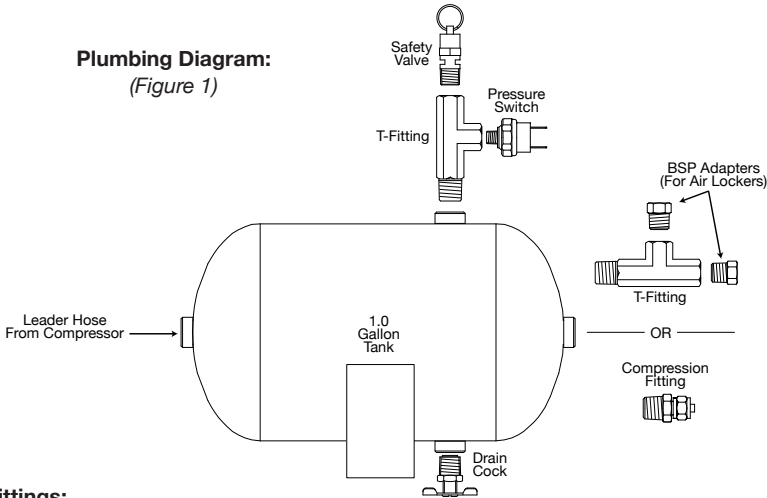

### Tank Fittings:

Install supplied fittings for the air tank in areas where they are most appropriate for your installation using thread sealant. Make sure that the safety valve is installed in the top of the tank, and that the drain cock is installed in the lowest position of the tank. Be sure that all fittings are accessible since you may have to plumb each fitting as needed to utilize the air tank properly.

### IMPORTANT:

- Tank is rated to 150 PSI maximum working pressure, however the kit is originally packaged with a 105 PSI pressure switch.
- Tank is **NOT** to be used as a breathing device.
- Bleed pressure from tank before servicing or adding attachments.
- Use only attachments or tools rated for 105 PSI working pressure or less.

### CAUTION! DO NOT PRESSURIZE YOUR TANK UNTIL YOU HAVE INSTALLED ALL NECESSARY PORT FITTINGS AND ACCESSORIES.

- Apply sealant to threads of fittings prior to assembly and tighten each part with a wrench.
- Do not over tighten if your port fittings are made from brass, since brass threads can be stripped.
- Always release air from tank before servicing.

### WARNING: FAILURE TO DRAIN TANK AND REMOVE CONDENSATION WILL CAUSE TANK TO RUST PREMATURELY.

- To remove accumulated condensation inside the tank, bleed pressure from tank until pressure is approximately 5 PSI to 20 PSI using drain cock.
- Drain water from tank by opening the drain cock drain valve and close after draining tank.
- If drain cock valve is plugged, release all air pressure from tank, remove drain valve and clean, then reinstall.

**IMPORTANT:** Replace air tank 2 to 5 years from date air tank was first used. Adhering to air tank draining guidelines will prolong the life of your air tank.

**PLEASE NOTE: RUSTED TANKS CAN FAIL CAUSING EXPLOSIONS OR FATAL INJURIES.** Discard tank immediately if tank is rusted.

**SAFETY VALVE:** When using a safety pressure relief valve, point the safety pressure relief valve away from your body when releasing air. Use the pull ring on the safety relief valve to vent pressure from the tank before servicing.

## ULTRA-LIGHT DUTY ONBOARD AIR SYSTEM

### 98C AIR COMPRESSOR INSTALLATION

---

Your Ultra Light Duty Onboard Air System comes complete with a 98C, 10% duty cycle compressor. Please follow the installation instructions that follow to enjoy the best use of your onboard air system.

#### **CAUTION - To reduce risk of electrical shock or electrocution:**

- Do not disassemble the compressor. Do not attempt repairs or modifications. Refer to qualified service agencies for all service and repairs.
- Do not use this product in an area where it can fall or be pulled into water or liquids.
- Do not reach for this product if it has fallen into liquid.
- Use this compressor with 12-volt DC systems only.
- This product should never be left unattended during use.

#### **Guidelines for Selecting Mounting Location:**

The selection of proper mounting location for your air compressor will help ensure a long and trouble free compressor service life. Please pay close attention to the following:

- Select a **FLAT, UPRIGHT & SECURE LOCATION** where the compressor can be mounted.
- To maximize air compressor performance, install compressor as **CLOSE TO THE BATTERY** as possible so that length of positive lead wire is as short as possible.
- This compressor is moisture & dust resistant, but **NOT WATERPROOF** or **DUSTPROOF**. Do not mount compressor in locations where the unit is likely to come in contact with water or excessive dirt.
- If it is necessary to mount the air compressor further from the battery, such as inside your vehicle or in the bed of your pickup, **VIAIR** recommends using wire larger than 12 AWG as a positive lead for remote installation.
- Do not mount compressor near areas where flammable liquids are stored.
- Use thread sealant for proper fitting installation. Thread tape is not recommended. Properly sealed, recommended torque for 1/4" and 3/8" is 12~15 ft. lbs. Recommended torque for 1/8" is 10~11 ft. lbs.

#### **98C Compressor Wiring:** (See Figure 3 on back of manual)

1. Disconnect ground cable from vehicle's battery.
2. Temporarily position the air compressor in the location where it will be mounted.
3. Route ground wire to the negative post of the battery or to an appropriate grounding point and cut ground wire to length as needed.
4. Mount the 98C air compressor with the two 13/64" (5 mm) bolts, nuts, washers, and locking washers provided. Use of thread locker is recommended.
5. This air compressor comes with a heavy duty heat resistant stainless steel braided leader hose. This leader hose is designed to prolong the life of your air line. Do not remove this leader hose from air compressor.
6. **IMPORTANT:** Please note; the leader hose that came with your compressor has a built-in inline check valve pre-installed. Do not remove inline check valve from leader hose.
7. To mount hose bracket, drill holes with 3/16" drill bit and push self-anchoring hose bracket pin into hole. Route leader hose through hose bracket and secure hose by pressing bracket clamp into locked position.
8. To remove hose from the hose bracket, simply press down on the hose clamp release tab to release bracket clamp.
9. Connect compressor's positive lead wire to one of the leads of your pressure switch.
10. Make sure that your compressor setup is properly fused. The 98C pulls approximately 13 amps of power.
11. Always locate fuse as close as possible to power source.
12. Before connecting to power source, check to make sure that all connections are made properly.
13. Connect and test compressor system by running the compressor for a short time to build up pressure in your air tank.
14. Once air pressure reaches preset cut out pressure of your pressure switch, the compressor will shut off. Inspect all air line connections for leaks with soap and water solution. If a leak is detected, the air line may not be cut squarely or pushed all the way in. Tighten connections if needed.

# ULTRA-LIGHT DUTY ONBOARD AIR SYSTEM

## 98C OPERATING INSTRUCTIONS

**IMPORTANT:** The 98C has a maximum working pressure of 130 PSI and is capable of 10% duty cycle. Always operate the compressor at or below the MAXIMUM PRESSURE RATING of the compressor. Operation exceeding maximum pressure ratings and or duty cycle will result in damage to air compressor.

1. To prevent discharge of your vehicle's battery and to provide peak performance, we strongly recommend that you keep the vehicle's engine running while using the air compressor.
2. ONLY OPERATE THE AIR COMPRESSOR IN WELL-VENTILATED AREAS.

### 98C Compressor Maintenance & Repairs:

1. Periodically check all electrical and fitting connections. Clean and tighten as needed.
2. Periodically check all mounting screws. Tighten as needed.
3. Regularly clean dust and dirt from compressor.
4. Your air compressor is equipped with permanently lubricated, maintenance-free motor. Never lubricate compressor.
5. Repairs should be performed by Manufacturer or Manufacturer's Authorized Service Agencies only.

**CAUTION:** Never touch the air compressor or fittings connected to the air compressor with bare hands during or immediately after use. Leader hose and fittings will become very HOT during and after use.

**NOTE:** Always mount the compressor at a point higher than the inlet port of the tank to keep moisture from being able to seep back to the tank.

## PRESSURE SWITCH WITH RELAY INSTALLATION

Your VIAIR Ultra-Light Duty Onboard Air System comes complete with a pressure switch and a 40-amp relay that will turn on the compressor at 80 PSI, and off at 105 PSI. The pressure switch has a 1/8" NPT inlet at the bottom that will need to be installed into the 1/8" NPT port of the T-fitting supplied in package #2 using thread sealant to allow it to be plumbed directly to your air tank. *(For Relay installation, see Relay Wiring Schematic contained in Figure 2.)*

### Pressure Switch Installation Tips:

1. Never install your pressure switch in direct line from the inlet port coming from the compressor. Tank pressure can be misread by the pressure switch. Mount the pressure switch on the tank where it receives air pressure reading from deflected air.
2. Never use a pressure switch that is rated beyond your compressor's rated Maximum Working Pressure (130 PSI).
3. Replace with P/N 90101 if the pressure switch requires replacement.

### Testing Your Onboard Air System:

Run the system to build pressure in tank. When air pressure reaches the pressure switch cut out pressure, the compressor will shut off. Inspect air line connections for leaks with soap and water sprayed with a spray bottle onto connections. If leaks are detected, lines may not be installed properly. Periodically check your system in this manner should your compressor turn on more often than normal without frequent air use.

**Relay Wiring Schematic:**  
(Figure 2)

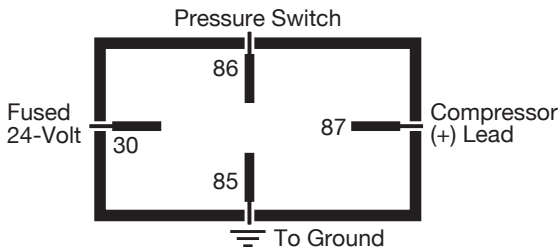

# ULTRA-LIGHT DUTY ONBOARD AIR SYSTEM

## COMPRESSOR APPLICATION GUIDE

---

To ensure that you get the highest level of satisfaction from your compressor performance, refer to information below:

### VIAIR COMPRESSOR REFERENCE CHART

COMPRESSOR SERIES	MAX. WORKING PRESSURE	DUTY CYCLE (100 PSI @ 72°F)
090 SERIES	120 PSI	9%
092 SERIES	120 PSI	9%
095 SERIES	120 PSI	9%
097 SERIES	130 PSI	10%
098 SERIES	130 PSI	10%
100 SERIES	130 PSI	15%
250 IG SERIES	150 PSI	100%
275 SERIES	150 PSI	25%
280 SERIES	150 PSI	30%
325 SERIES	150 PSI	33%
330 IG SERIES	150 PSI	100%
350 SERIES	150 PSI	100%
380 SERIES	200 PSI	100%
		55% @200 PSI
400 SERIES	150 PSI	33%
420 SERIES	150 PSI	33%
425 SERIES	175 PSI	33% @175 PSI
		50%
444 SERIES	200 PSI	100%
		50% @200 PSI
450 SERIES	150 PSI	100%
450 IG SERIES	150 PSI	100%
460 SERIES	150 PSI	100%
480 SERIES	200 PSI	100%
		50% @200 PSI
485 SERIES	200 PSI	100%
		100% @200 PSI

### ABOUT COMPRESSOR DUTY CYCLE:

Duty cycle refers to the amount of time a compressor can be operated in a given time period at 100 PSI, and a standard ambient temperature of 72° F. It is commonly expressed in percentage format:  $\text{Compressor on time} \div (\text{on time} + \text{off time}) = \text{Duty Cycle \%}$ .

### ONE-HOUR DUTY CYCLE

(100 PSI @ 72°F)

	MINUTES ON / MINUTES OFF
9%	5 Min. On / 55 Min. Off
10%	6 Min. On / 54 Min. Off
15%	9 Min. On / 51 Min. Off
20%	12 Min. On / 48 Min. Off
25%	15 Min. On / 45 Min. Off
30%	18 Min. On / 42 Min. Off
33%	20 Min. On / 40 Min. Off
50%	30 Min. On / 30 Min. Off
100%	1 Hour Run Time

**NOTE:** All compressors, regardless of rated duty cycle, require sufficient rest time in between cycles to allow for partial or complete heat dissipation. Heat dissipation rates may vary depending on ambient temperatures and operating conditions.

### ABOUT RATED WORKING PRESSURE:

To ensure trouble free service life of your compressor, always operate compressor within rated working pressure of the compressor. Never use a pressure switch with a higher cut-off pressure than compressor's rated working pressure.

# ULTRA-LIGHT DUTY ONBOARD AIR SYSTEM

## TROUBLESHOOTING GUIDE:

PROBLEM	POSSIBLE CAUSE(S)	CORRECTIVE ACTION
Tank pressure drops when compressor (s) shut off	<ol style="list-style-type: none"><li>1. Loose drain cock</li><li>2. Check valve leaking</li><li>3. Loose connections</li></ol>	<ol style="list-style-type: none"><li>1. Tighten drain cock</li><li>2. Replace check valve or compressor(s)</li><li>3. Check all connections with soap and water solution and tighten</li></ol>
Compressor runs continuously and air flow lower than normal	<ol style="list-style-type: none"><li>1. Excessive air usage</li><li>2. Loose connections</li><li>3. Worn piston ring or inlet valve</li></ol>	<ol style="list-style-type: none"><li>1. Decrease air usage</li><li>2. Check all connections with soap and water solution and tighten</li><li>3. Repair or replace compressor</li></ol>
Compressor runs continuously causing safety valve (if equipped) to open	<ol style="list-style-type: none"><li>1. Bad pressure switch</li><li>2. Defective safety valve</li></ol>	<ol style="list-style-type: none"><li>1. Replace pressure switch</li><li>2. Replace safety valve</li></ol>
Excessive moisture in discharge	<ol style="list-style-type: none"><li>1. Excessive water in air tank</li><li>2. High humidity</li></ol>	<ol style="list-style-type: none"><li>1. Drain tank, tilt tank to drain Drain tank more frequently</li><li>2. Move compressor to area with less humidity, or add water trap</li></ol>
Compressor will not run	<ol style="list-style-type: none"><li>1. No power, or power switch in OFF position</li><li>2. Blown fuse</li><li>3. Motor overheats</li><li>4. Faulty pressure switch</li></ol>	<ol style="list-style-type: none"><li>1. Make sure compressor switch is ON</li><li>2. Disconnect compressors from power source, replace fuse (Refer to Specifications section for correct fuse amperage)</li><li>3. Let compressors cool off for about 30 Minutes to allow thermal overload switch reset</li><li>4. Replace pressure switch</li></ol>
Excessive knocking or rattling	<ol style="list-style-type: none"><li>1. Loose mounting bolts</li><li>2. Worn bearing on eccentric or motor shaft</li><li>3. Cylinder or piston ring is worn</li></ol>	<ol style="list-style-type: none"><li>1. Tighten mounting bolts</li><li>2. Repair or replace compressor</li><li>3. Repair or replace compressor</li></ol>

**CAUTION: NEVER DISASSEMBLE COMPRESSOR WHILE COMPRESSOR IS PRESSURIZED.**

# ULTRA-LIGHT DUTY ONBOARD AIR SYSTEM

## AMERICAN WIRE GAUGE GUIDE 12-VOLT:

Amp Draw	Length of wire from battery to compressor (in feet)			
	5	10	15	20
5	16	16	16	14
10	16	14	12	10
15	16	12	10	10
20	14	10	10	8
25	14	10	8	6
30	12	10	8	6
40	12	8	6	6
50	10	6	6	4
60	10	6	4	4

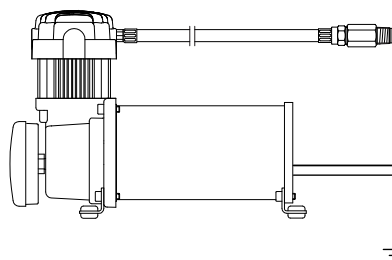

**Wiring Diagram:**  
(Figure 3)

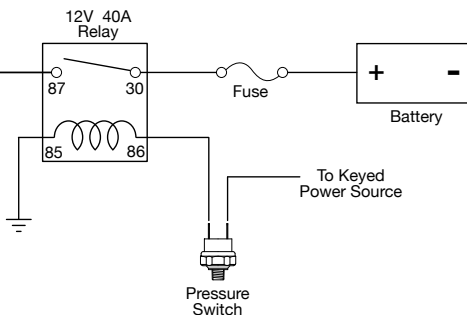

### LIMITED WARRANTY:

VIAIR® Corporation warrants this product, when properly installed and under normal conditions of use, to be free from defects in workmanship and materials for a period of one year from its original date of purchase. To receive warranty service or repair, please contact VIAIR® Corporation.

Returns should be made within one year of the date of purchase, after a Return Goods Authorization (RGA) number has been assigned by VIAIR® Corporation. For complete warranty details, please visit: [www.viaircorp.com/warranty](http://www.viaircorp.com/warranty)

### PLEASE NOTE:

THIS WARRANTY COVERS PRODUCT DEFECTS ONLY; IT DOES NOT COVER INCIDENTAL OR CONSEQUENTIAL DAMAGES AS RESULT OF MISUSE OR ABUSE.

This Manual is proprietary to VIAIR® Corporation and no ownership rights are hereby transferred. No part of the Manual shall be used, reproduced, translated, converted, adapted, stored in a retrieval system, communicated or transmitted by any means, for any commercial purpose, including without limitation, sale, resale, license, rental or lease, without the prior express written consent of VIAIR®.

VIAIR® does not make any representations, warranties or guarantees, express or implied, as to the accuracy or completeness of the Manual. Users must be aware that updates and amendments will be made from time to time to the Manual. It is the user's responsibility to determine whether there have been any such updates or amendments. Neither VIAIR® nor any of its directors, officers, employees or agents shall be liable in contract, tort or in any other manner whatsoever to any person for any loss, damage, injury, liability, cost or expense of any nature, including without limitation incidental, special, direct or consequential damages arising out of or in connection with the use of the Manual.

All third party product names, logos, and brands are property of their respective owners. All company, product service and trademark names are for identification purposes only. Use of these names, logos, and brands does not imply ownership or endorsement.



15 EDELMAN • IRVINE, CA 92618  
TEL: (949) 585-0011  
[www.viaircorp.com](http://www.viaircorp.com)